

SRS100

LONG DISTANCE ALUMINUM BAR TYPE

- Material : Engineering Plastic with Glass Fiber + α ,
Aluminum Bar
- Speed : 5 m/sec
- Temperature : -25 ~ 125°C

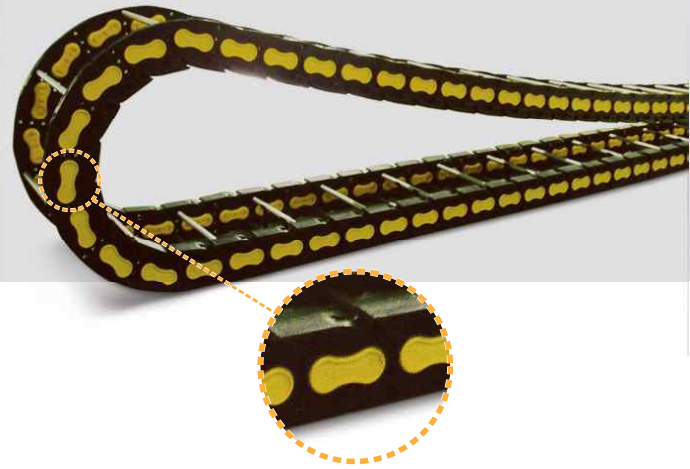

Structure

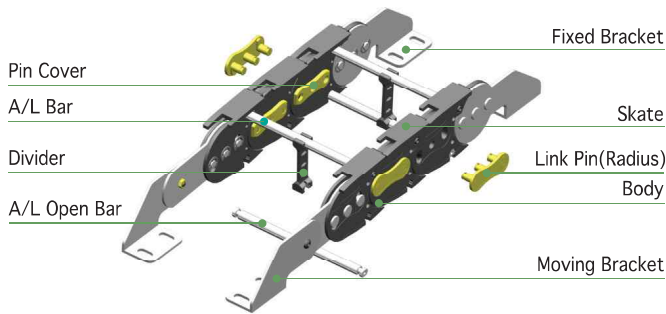

End Bracket

Fixed Bracket

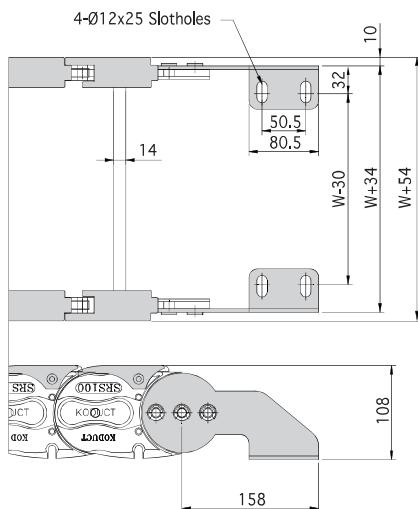

Moving Bracket

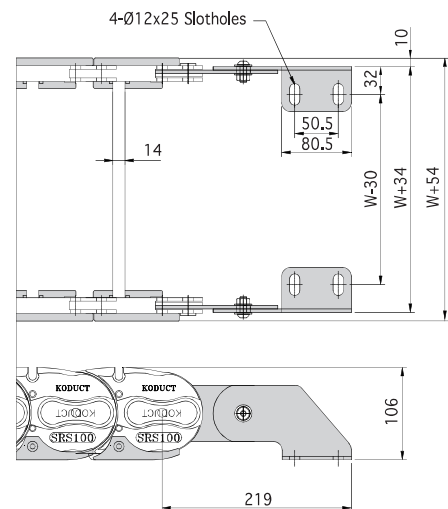

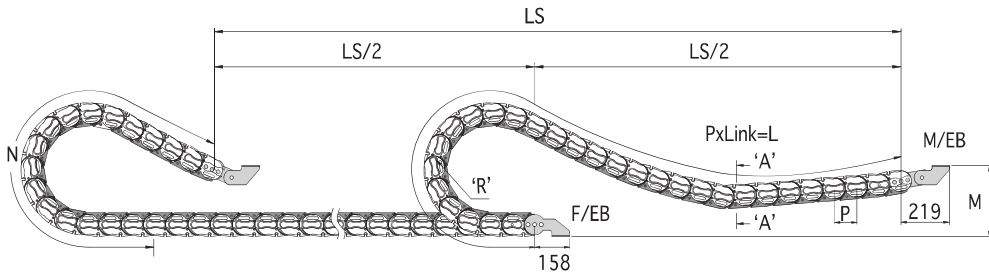

$L = \frac{LS}{2} + N$ LS: Total Machine Travel, L: Length, N: Safety Length+ πr , M: Moving Bracket Height, P: Pitch, F/EB: Fixed End Bracket, M/EB: Moving End Bracket

Section A-A

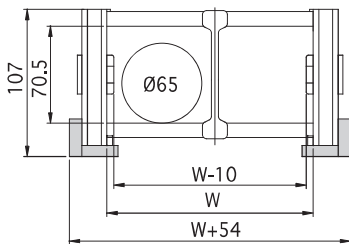

Divider

* Separator: Ø6 (Aluminum)

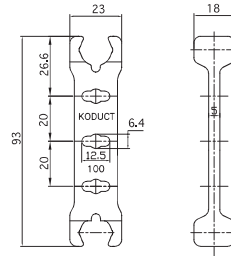

Specification

TYPE	W mm(inch)	Radius mm(inch)	Pitch mm(inch)	M mm(inch)	N mm(inch)	DVDR (ea)	1M (kg)	EB Set (kg)
SRS100	100 (3.937)	200 (7.874)	100 (3.937)	300 (11.811)	1,200 (47.244)	1	4.512	3.633
	150 (5.906)	250 (9.843)			1,400 (55.118)	1	4.747	
	200 (7.874)				1,500 (59.055)	1	4.917	
	250 (9.842)	300 (11.811)			2,100 (82.677)	2	5.149	
	300 (11.811)	350 (13.780)			2,500 (98.425)	2	5.317	
	350 (13.779)	400 (15.748)			3,500 (137.795)	4	5.591	
	400 (15.748)	500 (19.685)			6	5.759		
	500 (19.685)	500 (19.685)			6	7.374		
	600 (23.622)				6	7.933		

* Width 주문에 따라 제작가능 (Width follows in oder)

* 1inch = 25.4mm